

# M6<sup>C</sup><sub>TM</sub>

## artificial cervical disc

To accommodate the various anatomical ranges, the M6 artificial cervical disc is available in a variety of heights and endplate footprints.

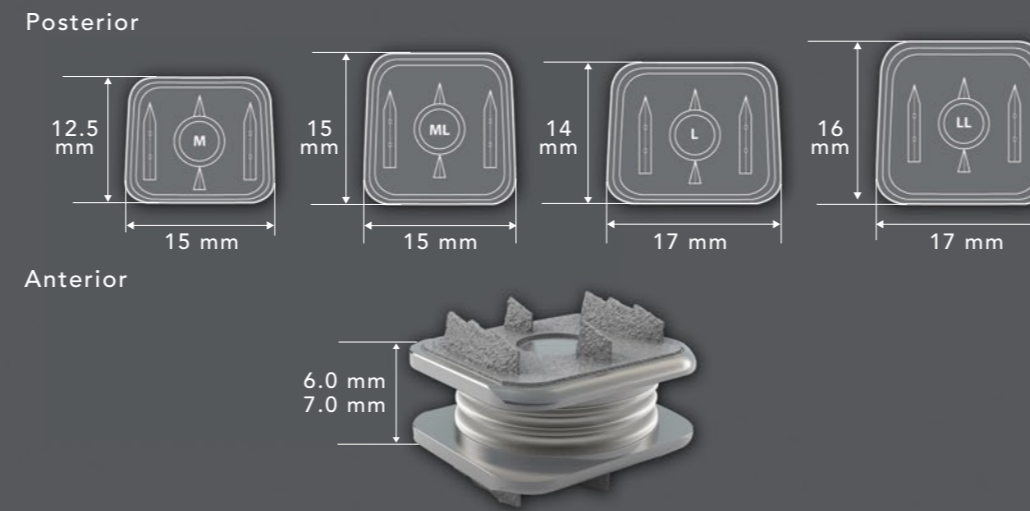

Endplate Footprint [mm]	Height [mm]	
Medium 15 width x 12.5 depth	6	7
Medium Long 15 width x 15 depth	6	7
Large 17 width x 14 depth	6	7
Large Long 17 width x 16 depth	6	7

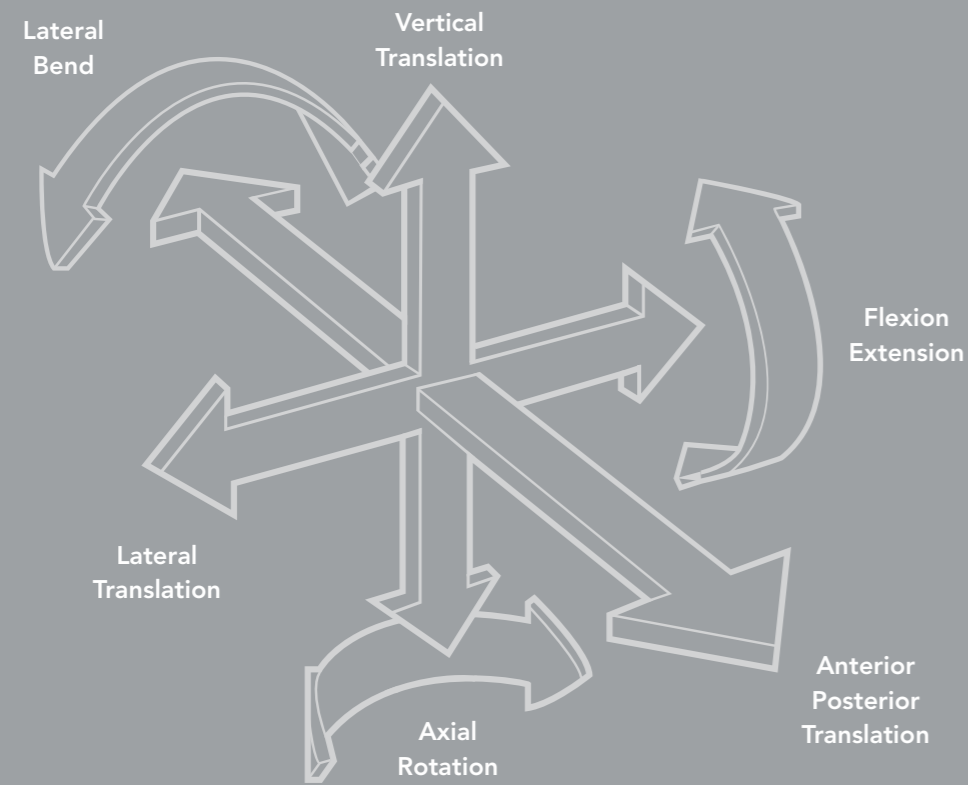

### Motion in all Directions

Kinematics is the study of motion and is a vital consideration in the design and development of any artificial disc prosthesis. An object that is completely free to move in a three dimensional space is said to have six degrees of freedom.

# M6<sup>C</sup><sub>TM</sub>

## artificial cervical disc

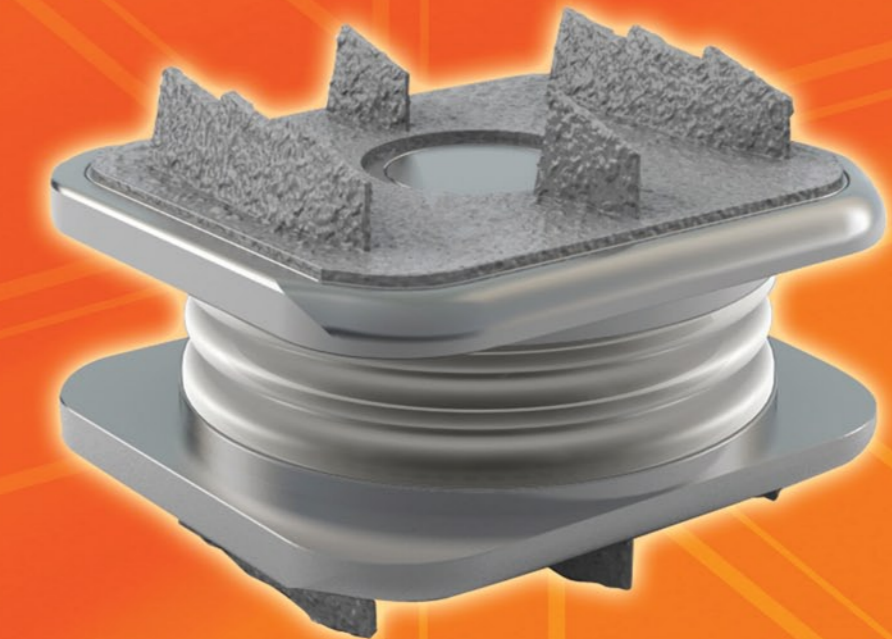

© 2008 Spinal Kinetics, Inc. SPINAL KINETICS, MOTION FOR LIFE, M6, CAP, 6 DEGREES OF NATURAL FREEDOM, and the Spinal Kinetics Spine Logo are trademarks or registered trademarks of Spinal Kinetics, Inc. in the U.S. and in other countries. U.S. Patent No. 7,153,325; Pending U.S. and foreign patent applications.

595 North Pastoria Avenue  
Sunnyvale, CA 94085  
Phone: +1-866-380-DISC (3472)  
Fax: +1-408-273-6018

email: [info@spinalkinetics.com](mailto:info@spinalkinetics.com)  
[www.spinalkinetics.com](http://www.spinalkinetics.com)



MKT 0011 Rev. 6



# M6<sup>C</sup>

## artificial cervical disc

The M6 artificial cervical disc is designed to replicate the anatomic structure and biomechanical performance of a natural disc. Its innovative design incorporates an artificial nucleus to allow axial compression and a woven fiber annulus for controlled range of motion in all six degrees of freedom. This physiologic motion is intended to preserve segmental motion and possibly prevent or delay additional adjacent level degeneration.

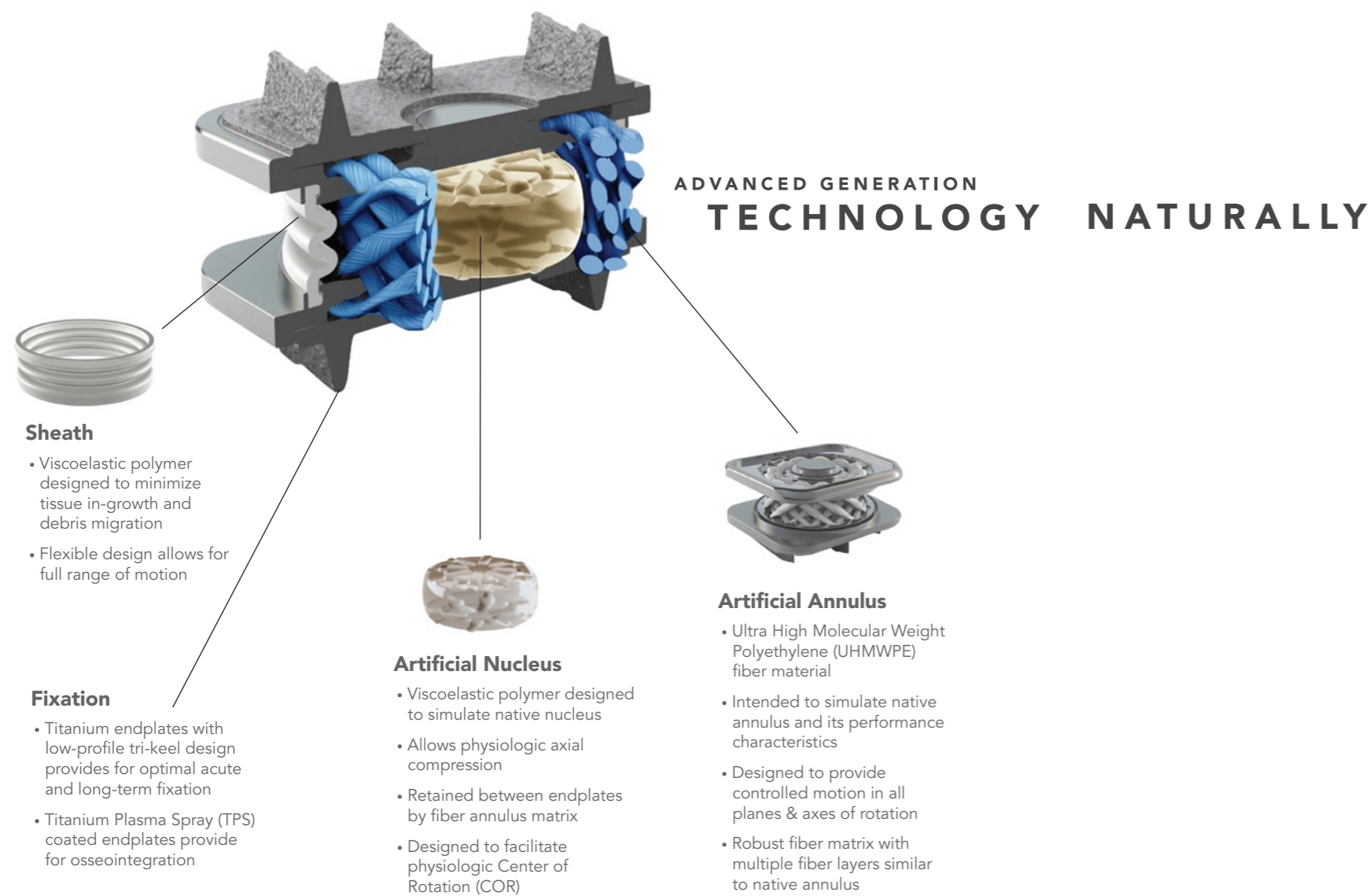

## M6-C Quality of Motion

Quality of Motion assesses how well the motion of an implanted functional spine unit approximates the motion of a healthy one over the entire range of motion, not just its endpoints. Through biomechanical testing, a load vs. angular displacement curve ("kinematic signature") is generated that allows assessment of the Quality of Motion parameters.

Biomechanical testing with the M6 artificial cervical disc has demonstrated equivalent Quality of Motion compared to the healthy disc. The innovative artificial fiber annulus and nucleus construct of the M6 is the critical component in replicating this physiologic motion, as it is designed to provide the necessary restraint and control needed throughout the spine's natural range of motion.

C5-C6 Flexion-Extension Load-Displacement Curves  
150 N Follower Load

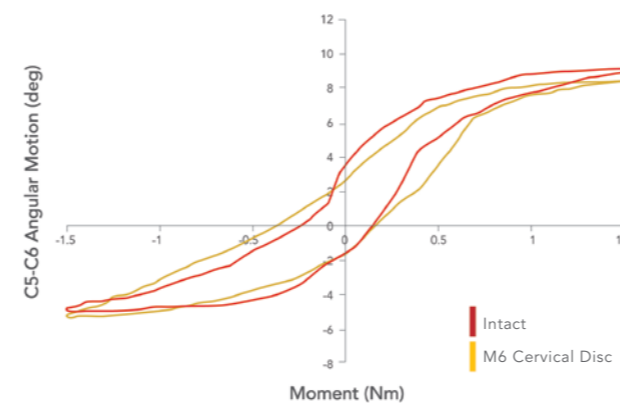

Biomechanical results showing the M6 cervical disc (orange) maintained total ROM (13.5) vs. the intact disc (13.3) with excellent Quality of Motion. The "kinematic signatures" of the intact disc (red) and M6 cervical disc are nearly identical.

Patwardhan et al. Musculoskeletal Biomechanics Laboratory, Edward Hines Jr. VA Hospital, Hines, Illinois, USA

Single-Level M6 Case



M6 Cervical Disc Trial Placement

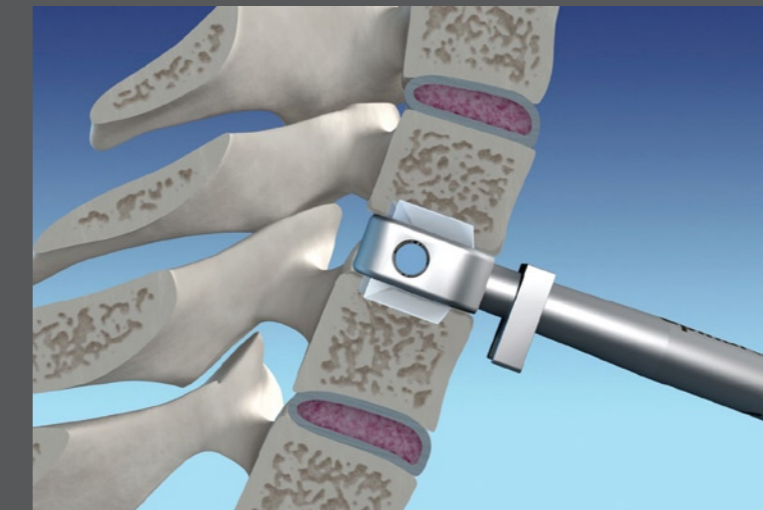

M6 Cervical Disc Chisel Insertion



M6 Cervical Disc Insertion

Multi-Level M6 Case

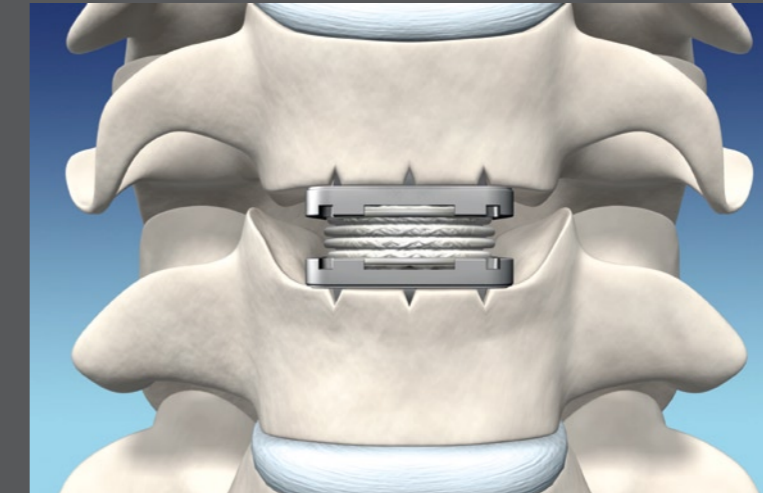

Implanted M6 Cervical Disc



## M6-C Surgical Instrumentation

The M6 surgical instrumentation system was designed with surgeon feedback for simple, safe, and reproducible implantation of the disc. Instrumentation includes Trials to assess optimal disc size and placement, corresponding Chisels to cut keel tracks for disc insertion, and Inserters to easily implant the M6 into the intervertebral space.

The M6 Trials and Chisels all incorporate the Spinal Kinetics CAP™ System (Center Alignment Port) that provides optimal alignment under fluoroscopy to the Trial and Chisel head in both A/P and lateral views to better assess midline placement.